

Curtain walls

NEW: forster thermfix vario HI –
Passiv House facades $U_g = 0.49 \text{ W}/(\text{m}^2\cdot\text{K})$

Security: fire protection EI30 – EI90

Burglar protection RC2–3

Bullet resistance FB4NS,
in steel and stainless steel

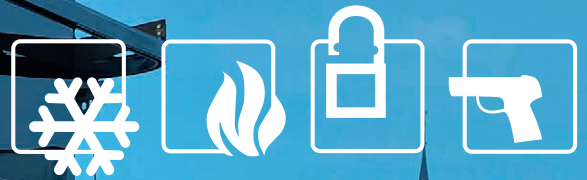

forsterthermfix.vario
forsterthermfix.varioHI
forsterthermfix.light

forster

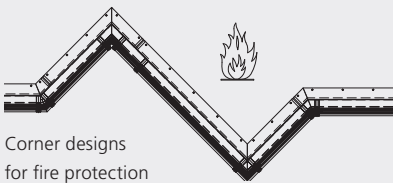
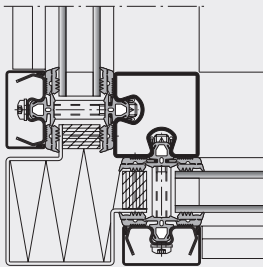
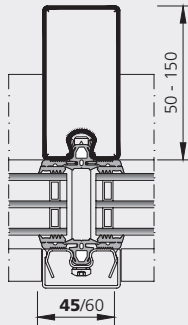
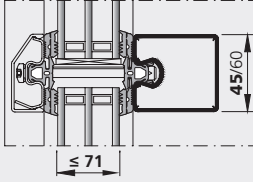

Corner designs
for fire protection

Steel glass construction
or steel-glass panels

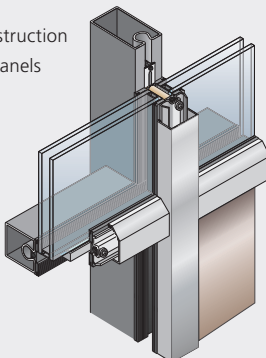

Production and assembly is now even more efficient. Clever processing tools save additional time, enhance the work piece accuracy and safety with pre-marked weatherstrippings.

Technical details for fire-resistance and safety

Material options	Steel, Stainless steel, grinded, grain 220-240 combination of steel/stainless steel/aluminium
Performance specifications*	<p>Thermal insulation: U_f-value from 1.0 W/(m²·K)</p> <p>Classification from CE-tests according to EN 13830:</p> <ul style="list-style-type: none"> • Resistance to wind load acc. to EN 12179: 3 kN, safety load 4.5 kN • Rain impermeability according to EN 12155: RE1200 • Air permeability according to EN 12153: AE (>600) • Sound insulation (EN ISO 140-3): R_w up to 45 dB • Impact resistance according to EN 14019: E5/I5 <p>Burglary resistance according to EN 1627-1630: RC 2-3</p> <p>Bullet resistance according to EN 1522-1523: FB4 NS</p> <p>NEW: Tested glass sheeting panels with a maximum dimension of 1500 x 3000 mm EI30 and EI60, are also possible (can be printed or enamelled)</p> <p>NEW: Corner building in class EI30 and EI60</p> <p>Fire resistance classification of construction products according to EN 13501-2: EI30, EI60, EI90, i<->o (E30/EW30, E60/EW60, E90)</p> <p>Reaction to fire of construction products acc. to EN 13501-1: class E</p> <p>EI30: proved combination of bullet resistance according to EN 1522-1523 FB4 NS and burglary resistance according to EN 1627-1630</p>
Systemmerkmale	<p>Extremely slender face width 45 mm, individual profile design and surface treatment</p> <p>Can be used over several storeys up to a height of 5000 mm</p> <p>Trouble-free assembly using mechanical T-joints</p> <p>NEW: Tools for positioning the clamping feet and seals with helpful markings</p>

*Refer to country-specific approvals

Facades for fire protection and more

FOR SAFETY & SECURITY. The system forster thermfix vario is a thermal insulated mullion and transom construction, based around a dry glazing security application system for fire, burglar and bullet protection. Corner designs tested in fire protection and bonded glass to panels up to a size of 1500 × 3000 mm create additional applications for all facades with high heat insulation and in line with safety requirements.

The internal side profiles made from steel or stainless steel take the load bearing function. Thanks to excellent static properties, impressive field sizes are possible with very narrow profile face widths of only 45 mm.

Thermally insulated doors and windows from the systems forster unico and unico XS can be integrated into the facade.





Curtain wall Hi

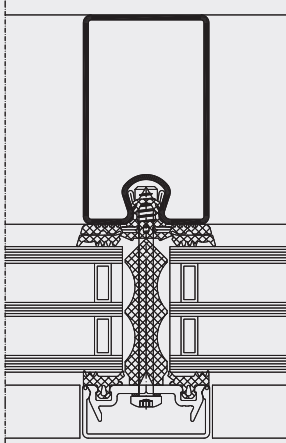

ENERGY EFFICIENT. The new system forster thermfix vario Hi offers excellent heat insulation at passive-house level in the phA class. Impressive dimensions are possible with a steel profile system such as the forster thermfix vario Hi. The certified passive house elements can be designed either with profiles of 45 mm or 60 mm widths.

Since this profile system is based on the standard mullion and transome construction from forster thermfix vario, many components can be used system-wide. This guarantees an identical appearance of the facade, particularly for buildings with different requirements, such as burglary resistance or fire protection within prescribed areas.

Production and assembly is made even more efficient with new aluminium pressure blocks. Clever processing tools save additional time, enhance the work piece accuracy and safety with pre-marked weatherstrippings.

You can find ideal combination elements in the system forster unico and forster unico XS. For example, for heat-insulated windows and doors.

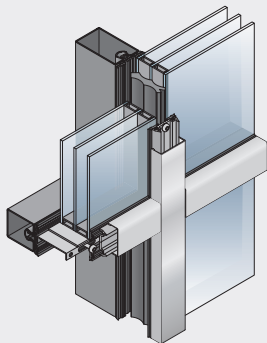

U_f 0,49 W/(m²·K)

cool, temperate climate



CERTIFIED COMPONENT

Passive House Institute



Politie Doentinchem, NL-Doentinchem

Thermally insulated facade, fire-resistant doors and glazings EW60

Technical details energy efficiency Hi

Material options	Steel, Stainless steel, grinded, grain 220-240 combination of steel/stainless steel/aluminium
Performance specifications*	Thermal insulation: U_f -value from 0.49 W/(m ² ·K) U_{CW} -value: 0.6 (with triple glass U_g 0.5 on 1500 × 3000 mm) Classification from CE-tests according to EN 13830: <ul style="list-style-type: none">• Resistance to wind load acc. to EN 12179: 3 kN, safety load 4.5 kN• Rain impermeability according to EN 12155: RE1350• Air permeability according to EN 12153: AE (>600)• Impact resistance according to EN 14019: E5/I5
System properties	Extremely slender face width 45 mm, individual profile design and surface treatment Trouble-free assembly using mechanical T-joints NEW: Aluminium pressure strips for convenient, efficient installation NEW: Tools for positioning the clamping feet and seals with helpful markings

*Refer to country-specific approvals



Residential home CH-Balstahl
Thermally insulated facade and doors



Facade with attachment profiles

FLEXIBLE, FAST, ECONOMICAL. The system offers great configuration flexibility to both planner and architect because of the unlimited choice in the sub-structures. Forster thermfix light makes it possible to mount a sealing system on commercially-available steel and aluminium profiles as well as on wooden sub-structures. The system is characterized by basic and quick processing allowing improved economics.

Possible variants are vertical curtain walls, sloped glazing and sloped glazing with fire protection. Combine the thermally insulated doors and windows from the system forster unico and unico XS with it.

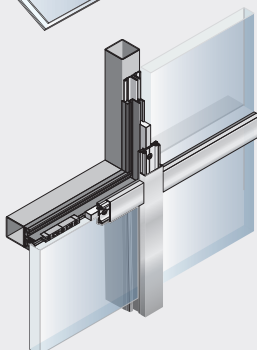
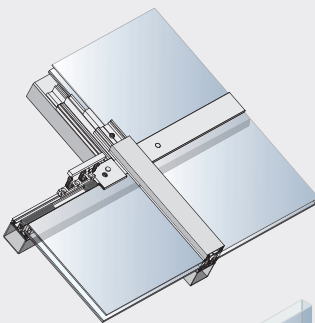
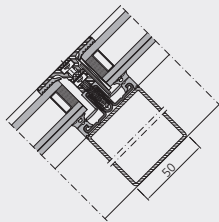
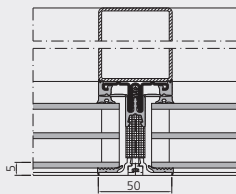
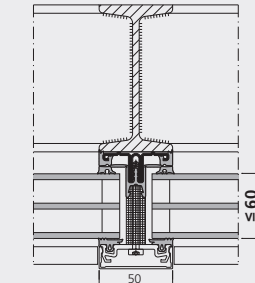

Technical details

Material options	Sub-structures in steel, aluminium, wood Forster attachment profiles in steel or aluminium, pressure profiles in aluminium, cover profiles in aluminium or stainless steel
Performance specifications*	Thermal insulation: U_F -value 1.0–2.2 $W/(m^2 \cdot K)$ (S) Thermal insulation: U_F -value 1.1–2.2 $W/(m^2 \cdot K)$ (V) (depending on the infill thickness) when using a rebate insulator
(S) sloped glazing (V) vertical curtain wall	Tested fire resistant sloped glazing EI30/EI60/E30/E60 Tested based on the product standard EN 13830: <ul style="list-style-type: none"> • Reaction to fire of construction products acc. to EN 13501-1: class E (S)(V) • Curtain walls with increased volume of water (3l/min\cdotm2) (S) • Air permeability 1200 Pa (S) / AE 750 (V) • Rain impermeability 1200 Pa (S) / R7 600 Pa, dynamic P_{max} 1125 Pa (V) • Resistance to wind load 2400 Pa, safety load 3600 Pa (S) / 3000 Pa (V)
	Safety test: CSTB 3228 (50 kg, 2400 mm) 1200 Joule (S)
	Impact resistance according to EN 14019: I 5 (internal), E 5 (external)
	Slope 0–75° (inside), for outside use 10–75° (S)
System properties	Extremely slender visible sections: rafter and transom 50 mm Individual profile and surface design Basic and quick processing because of few system components

*Refer to country-specific approvals



*Maison de la Musique, CH-Martigny
Wärmegeädämmte Pfosten-Riegel Fassade*

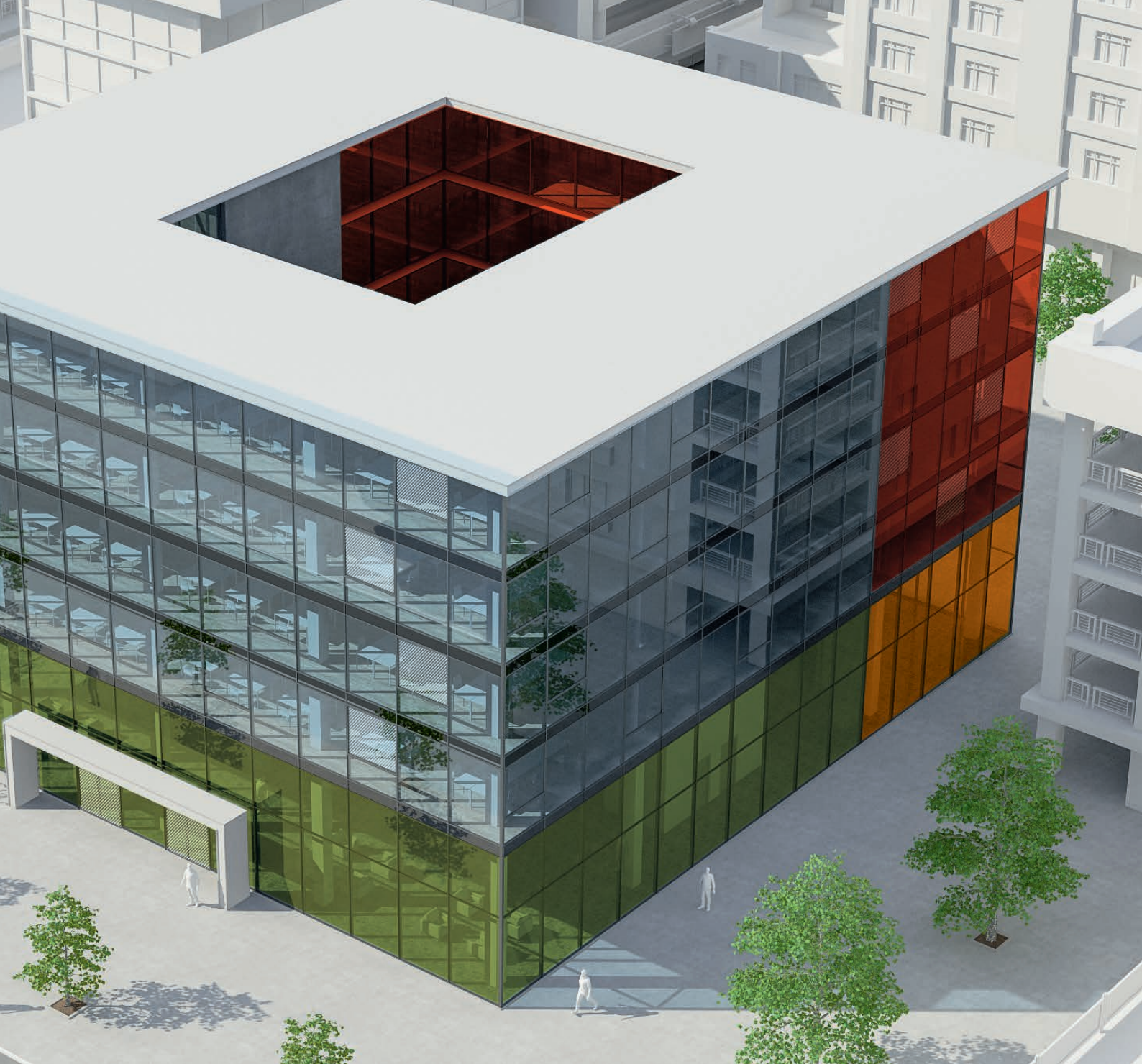

forster thermfix vario Hi

- Curtain wall with high thermal insulation at Passiv House level phA

Windows forster unico XS

- Thermal break
- MINERGIE
- With ultra-slim appearance
- Burglary-resistance

forster thermfix vario

- Burglary-resistance
- Bullet-resistance
- Thermal break

Doors forster unico

- Thermal break
- Burglary-resistance
- Bullet-resistance

forster thermfix vario

- Fire protection
- Thermal break

Windows forster unico

- Fire protection
- Thermal break

forster thermfix vario

- Fire protection
- Burglary-resistance
- Bullet-resistance
- Thermal break

938366/10013852/11-16